

FIRAT

**TUNEL TYPE
PVC DRAINAGE
PIPE AND FITTINGS**

FIRAT

Türkoba Köyü P.K. 12
34907 Büyükçekmece İstanbul / TURKEY
T: +90 (212) 866 41 41 - 866 42 42
F: +90 (212) 859 04 00 - 859 05 00
www.firat.com
fiat@fiat.com
info@fiat.com



TS 13492

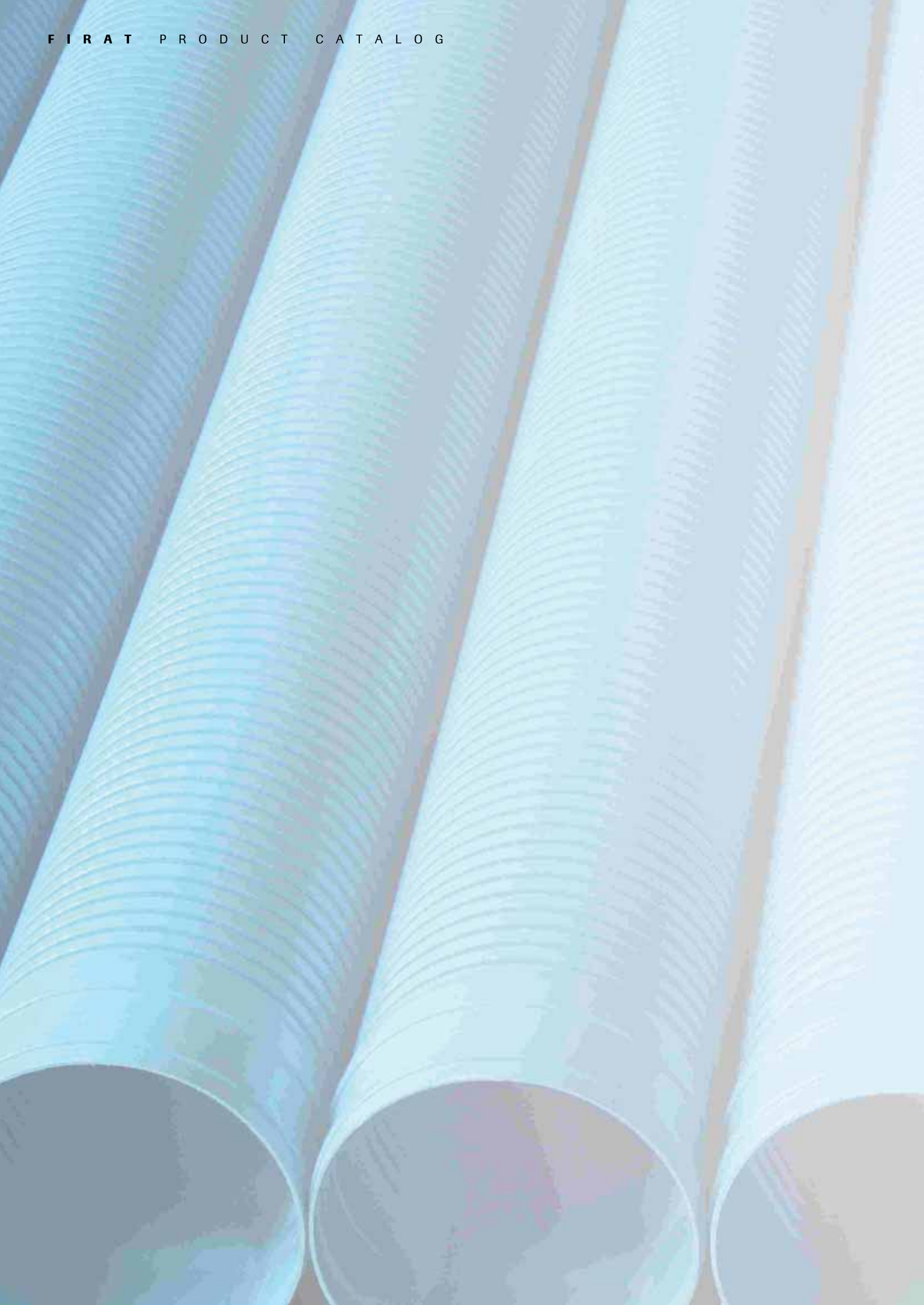

CONTENTS

| | |
|--|-----------|
| Introduction | 02 |
| Raw Material | 06 |
| General information | 08 |
| Features of Tunnel Type uPVC Drainage Pipe and Fittings | 08 |
| Areas of Use of Tunnel Type uPVC Drainage Pipe and Fittings | 09 |
| Advantages of Tunnel Type Drainage Pipe and Fittings | 10 |
| Technical Features of Tunnel Type Drainage Pipe and Fittings | 11 |
| Tunnel Type uPVC Drainage Pipe and Fittings | 13 |
| Tunnel Type uPVC Drainage Pipes | 15 |
| Tunnel Type uPVC Drainage Fittings | 16 |
| Our Quality Understanding | 18 |
| Tunnel Type uPVC Drainage Pipe and Fittingsı Quality Control Assurance | 20 |
| Tunnel Type uPVC Drainage Pipe and Fittingsı Quality Certificates | 21 |
| Chemical Resistance of Tunnel Type uPVC Drainage Pipes | 22 |
| FIRAT Export Map | 24 |



FIRAT

FIRAT was established in 1927 to carry out production in construction materials sector. Setting off with the principles of "always high quality production" and "high quality product range", FIRAT succeeded to become **"a leader company in its sector"** and **"leading exporter of the sector"** with major progresses it has achieved in Turkey in a short time.

FIRAT carries out production for various sectors such as construction, agriculture, automotive, medical and white appliances with its plastic based products. Carrying out its productions for these sectors in its modern factories located in Istanbul-Büyükcemece and Ankara-Sincan, FIRAT owns one of the three largest production facilities in Europe.

According to 2011 data of Istanbul Chamber of Commerce, FIRAT has the 57th standing in the listing of Turkey's 500 largest industrial organizations. FIRAT has the 51st standing in the private sector rating of the same listing. FIRAT is the 72nd organization which pays the highest amount of tax in Turkey. Taking the 117th place in the listing of "Turkey's Highest Exporting Manufacturers 2011" of Turkish Exporters Assembly, FIRAT is the leading exporter of its sector.

As of end of 2012, FIRAT has 1700 employees. Adopting the understanding of "human is the most important asset", FIRAT performs regular on-the-job trainings to improve both professional experience and provide corporate knowledge of the employees.



Product Variety and Groups

FIRAT, offers more than 4500 product varieties. FIRAT manufactures its products as integrated systems to ensure that customers ensure highest benefit and satisfaction with these products.

PVC Door and Window Profiles, PVC Gutters, PVC Clean Water Pipes and Fittings, PVC Waste Water Pipes and Fittings, PVC Hose Groups, Rubber and PE Based Hoses, PPRC Sanitary Installation Pipes and Fittings, PP Composite Pipes and Fittings, HDPE Pipes and Fittings, PP&PE Panels, LDPE Pipes and Fittings, EF Fittings, PE 80 Natural Gas Pipes, Drainage Pipes, Tunnel Type Drainage Pipes, Double-Wall Cable Conduits, EPDM Seal Production, Thousands of products of FIRAT offer in service at various locations of Turkey and throughout the world such as TPE Seal, Metal Injection (hinge and window fittings), PEX Mobile System and Floor Heating Pipes, PEX Pipes and Metal Fittings, Pex Al Pex Pipes, Sprinkler Pipes and Drip Irrigation Pipes.

FIRAT is the only company which manufactures all components that constitute PVC Window and Door systems except for glazing and screw in the world plastics sector. FIRAT manufactures all PVC Profile, EPDM Seal, TPE Seal, Support Sheet and Metal Accessories with integration in its own facilities since complete intercompatibility of PVC Windows and Doors can only be achieved through production at the same source.

FIRAT manufactures FKS sewage pipes which have a testable operating life up to 100 years. These pipes which can be manufactured up to a diameter of 3600 mm with HDPE (high density polyethylene) rawmaterial are resistant against seismic movements, reptiles, plant roots and chemical wastes. FKS pipes are manufactured with technology and under licence of German Kraih company.

Again manufactured in FIRAT facilities, Double Wall Triplex Pipes which are employed in outdoor installations and underground levels are mainly used in sewage lines and also for domestic connections, rain water drainage lines, industrial waste water installations, water conveying channels and drainage systems. Triplex Pipes have major advantages in terms of high flow performance, external load resistance, extended operating life, ease of shipping and stocking, economy, resistance to chemicals, pricing and ease of maintenance, tightness and ability to install without wastage.



Firat developed FCS piping systems which is a new system with an operating pressure up to 10 bar to meet increasing high diameter and high operating pressure piping demand. FCS piping systems which ensure production of all pipes diameters at the range of 800 mm - 4000 mm have become a significant solution option for infrastructure needs with its lightweight, jointing with electro-fusion welding, easy and quick installation features.

FIRAT can perform rawmaterial analysis; source, torrent and wind strength, impact and jagged impact resistance, pressure, tensile and breaking strength, ring rigidity (resistance of FKS and Triplex pipes against soil load) in the most advanced test and analysis laboratories in the sector. Our products are only offered to the customers upon obtaining "Quality Approval".

FIRAT products which are subjected to all quality control products are offered to the market with "FIRAT Quality Assurance Certification". FIRAT is the only company in the sector who holds international quality certifications such as RAL, GOST, SKZ, BDS, SABS, EMI, DVGW, VDE, TSE and also all ISO/IEC 17025 accreditation, ISO 14001, OHSAS 18001, ISO 10002 ve ISO 9001 system certifications. Firat holds ISO 14001 Environment Management System certificate as a environmentally friendly manufacturer.



Products of FIRAT achieved customer satisfaction in more than 60 countries and got the standing they deserved.

FIRAT aims to utilize all of its resources, advance, grow and catch perfection and excellence with advanced technology for ensuring continuous customer satisfaction.

In line with the goals of perfectionism and excellence of FIRAT, our products are largely preferred due to features of reliability, ease of accessibility and after-sales support.

FIRAT Management Building



Raw Material

Manufactured from PVC raw material, FIRAT Tunnel Type Pipe and Fittings have no adverse effects on human health.

PVC raw material used in Tunnel Type Pipe and Fittings are purchased from companies such as PETKİM, ATOFINA, SABIC, SOLVAY etc. which are among the highest quality raw material manufacturers in the world and all delivered raw material are subjected to Acceptance Quality Control checks such as bulk density, grain thickness distribution, K number, viscosity number, moisture test.

PVC (Polivinyll Chloride)

PVC is one of the most valuable chemical components of the world chemistry sector which is used widely in a large variety of sectors. Polyvinyl Chloride is among the leading amorphous plastics. It is a powder polymer in white or light yellow color. No physical structure changes occur due to high resistance against acids, bases, fire, alcohol and benzene.

Polyvinyl Chloride Formulation

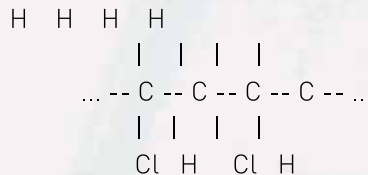

PVC Raw Material Tests



Moisture Determination Test



Viscosity and K Number Test



Grain Thickness Distribution Test



Solvent and Mixer

PVC Raw material Usage Areas:

More than 50% of the products manufactured using PVC raw material in the world is used in the construction sector. Since PVC-based products are convenient, easily mountable, sturdy and homogenous, they have displaced wood, concrete and clay which are traditional construction materials in many fields.

Products such as PVC-based door and window profile and sealing materials, pipe and installation materials, flooring materials, hobby materials, gutters and fittings, electrical cables and cable insulation materials, greenhouse protection materials, ceiling cladding, audio and video cassettes, long-plays, oxygen tents, blood and dialysis bags, serum hoses, waterproof raincoats, life vests, shoes and boots, aprons, baby clothes, toys, sports materials etc. are used in various areas mainly in construction sector and used in every moment of our daily lives. PVC-based products are considered as environment friendly since they are recyclable.

PVC Raw material Usage Method:

All raw material used in FIRAT products are subjected to acceptance quality control tests.

With our modern production line, raw material that used in PVC pipe production is processed into profiles without contacting with air in any manner.

All raw material and ratio formulations used in PVC pipe profiles are tested regularly at international independent laboratories and in our own laboratories.



General Information

Features of Tunnel Type PVC Drainage Pipe and Fittings

Firat Tunnel Type uPVC Drainage Pipe and Fittings are manufactured using full-automatic (extruder-corrugator-cutting) extrusion technology.

Firat Tunnel Type PVC Drainage Pipes; are manufactured according to DIN 4262-1 German norm and standards as Type C1 model in terms of shape and form.

Firat Tunnel Type uPVC Drainage Pipes are widely used in various infrastructure and drainage works.

Firat Tunnel Type uPVC Drainage Pipes conform to Specifications of General Directorate for Highways.

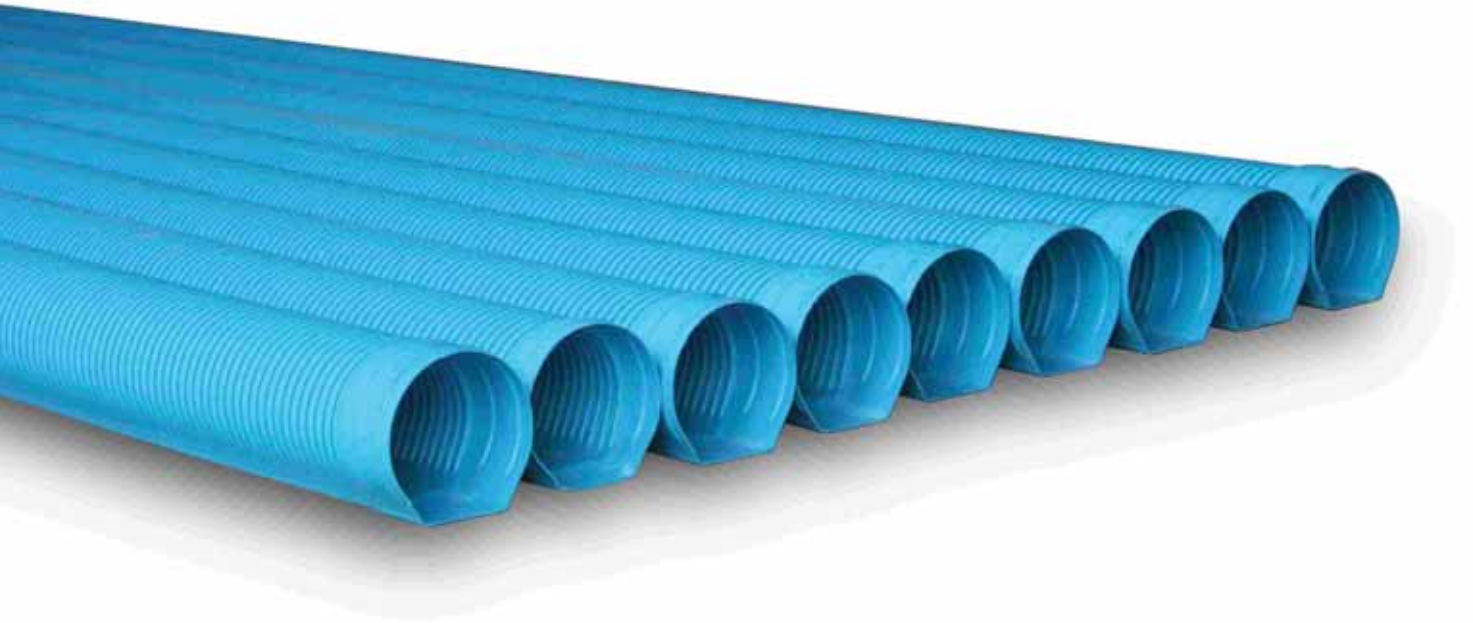

Firat Tunnel Type uPVC Drainage Pipe and Fittings ensure that any kind of floor water in the structures is drained with diameter options of 100 mm, 150 mm and 200 mm and 6000 mm length.

Firat Tunnel Type PVC Drainage Pipe and Fittings are suitable for long term utilizations since they are ecological and economical and able to maintain its physical structure.

Drainage system installation is carried out quickly since it can be mounted easily, it does not require demanding workmanship such as bending and bonding.

Areas of Use

- Highways, motorways drainage applications.
- Railway drainage applications.
- Dam, canals, irrigation infrastructures drainage applications.
- Airport infrastructure drainage applications.
- Drainage applications for structures such as school, hospital, hotel etc.
- Drainage applications for mass housings, industrial and sports facilities.



Features of Tunnel Type uPVC Drainage Pipe and Fittings

Advantages of Tunnel Type PVC Drainage Pipe and Fittings

- With PVC raw material high resistance to underground acidic and basic liquids is ensured.
- Horseshoe form, vertical groove of the internal and external structure ensures resistance to external forces.
- It can be installed easily with its bell mouth structure and flat base.
- It is lightweight and does not require additional construction vehicle for handling.
- Self bell shaped mouth section enables quick mounting.
- Since its base is flat flow and flow rate of water increases.
- It can be manufactured in 100 mm, 150 mm and 200 mm diameters with a length of 6 meters with and without perforation.
- With 220° perforation angle, the water does not return to the ground and high suction flow rate is realized.
- Since it is easy to install, it does not require trained personnel and demanding workmanship.
- Since all fittings have specially designed latch connection, separation does not occur at joints.
- It is durable against sun rays and external effects.
- Pipes manufactured without perforation can be used as collector.

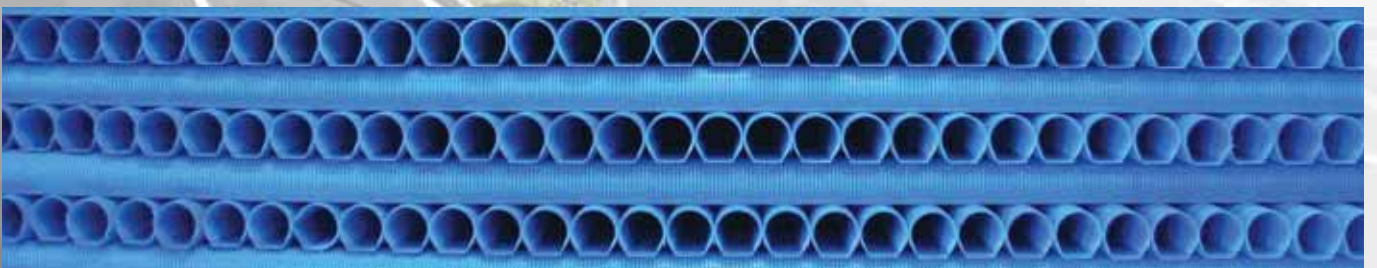

Technical Features of Tunnel Type PVC Drainage Pipe and Fittings

Concerning Standards

Tunnel Type PVC Drainage Pipe and Fittings: DIN 4262-1, TS 9128

Chemical Resistance Standard: ISO TR 10358

PVC Raw Material Standard: DIN EN 1905

TS 13492

Marking

Following details are embossed on Tunnel Type PVC Drainage Pipes for traceability.

FIRAT

PVC-U

DN/OD...Diameter

SN Class

DIN 4262-1,  TS 13492

Date



Tunnel Type uPVC Drainage Pipe Gradient and Flow rate Diagram

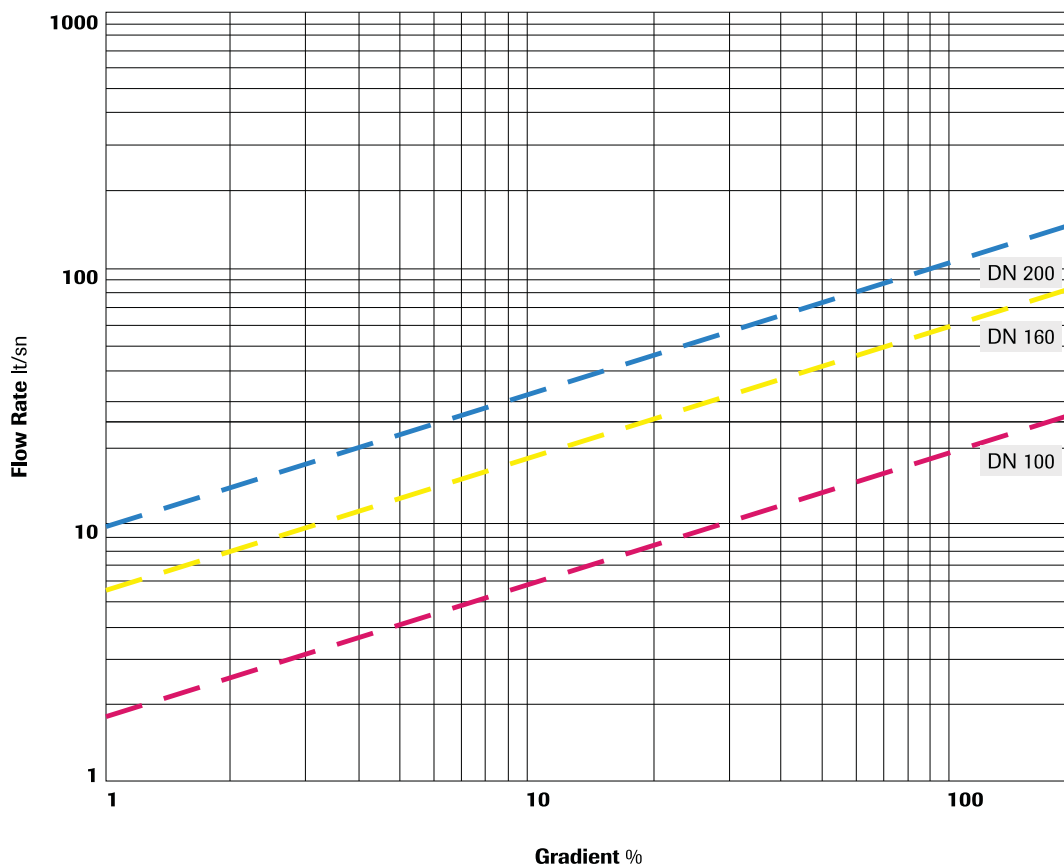



TUNEL TYPE PVC DRAINAGE PIPE AND FITTINGS





TUNNEL TYPE uPVC DRAINAGE PIPES

 TS 13492

| Product Code No | Nominal Diameter | Diameter (d) mm ±2,5 | Height mm ±2,5 | Profile Widht mm | Number of Slots piece / m | Quantity cm ² | Cross-section Area cm ² / m | Length (L) Bell Mouthed m | Length (ℓ) Without Bell Mouth / m |
|-----------------|------------------|-------------------------|-------------------|---------------------|------------------------------|-----------------------------|---|---------------------------------|--------------------------------------|
| 7324000254K | 100 | 110 | 110 | 10.15 | 396 | 82 | > 55 | 6.28 | 6.22 |
| 7324000318K | 150 | 160 | 160 | 14.66 | 408 | 182 | > 60 | 6.28 | 6.18 |
| 7324000381K | 200 | 210 | 210 | 16.06 | 360 | 318 | > 80 | 6.28 | 6.16 |

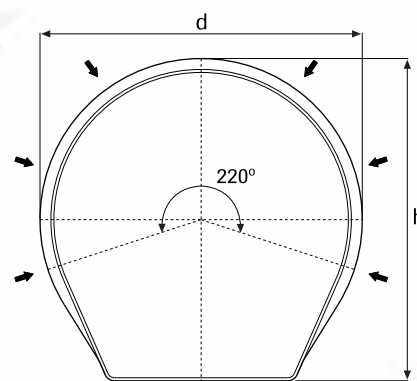
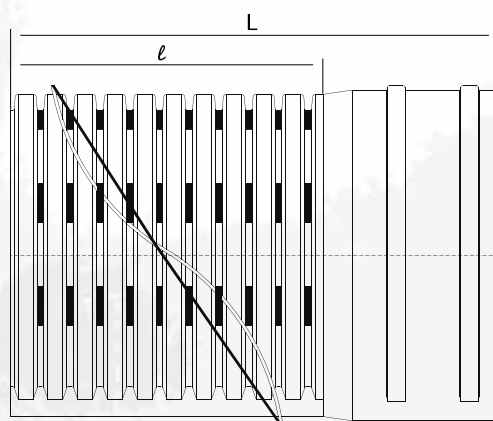

TUNNEL TYPE uPVC DRAINAGE FITTINGS

 TS 13492

SOCKET

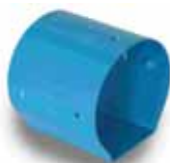

| Code | Diameter |
|------------|----------|
| 7122100010 | 100 |
| 7122160010 | 150 |
| 7122200010 | 200 |

TE PIECE



| Code | Diameter |
|------------|----------|
| 7122100030 | 100 |
| 7122160030 | 150 |
| 7122200030 | 200 |

CROSS TE

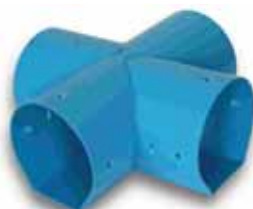

| Code | Diameter |
|------------|----------|
| 7122100080 | 100 |
| 7122160080 | 150 |
| 7122200080 | 200 |

30° ELBOW



| Code | Diameter |
|------------|----------|
| 7122100050 | 100 |
| 7122160050 | 150 |
| 7122200050 | 200 |

45° ELBOW

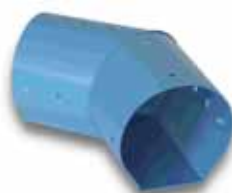

| Code | Diameter |
|------------|----------|
| 7122100055 | 100 |
| 7122160055 | 150 |
| 7122200055 | 200 |

TUNNEL TYPE uPVC DRAINAGE FITTINGS

 TS 13492

90° ELBOW

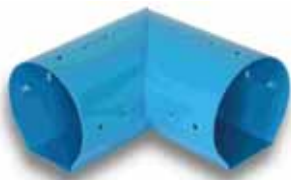

| Code | Diameter |
|-------------------|----------|
| 7122100070 | 100 |
| 7122160070 | 150 |
| 7122200070 | 200 |

45° Y PIECE



| Code | Diameter |
|-------------------|----------|
| 7122100020 | 100 |
| 7122160020 | 150 |
| 7122200020 | 200 |

OUTLET PIECE (with frog flap)



| Code | Diameter |
|-------------------|----------|
| 7122100100 | 100 |
| 7122160100 | 150 |
| 7122200100 | 200 |

END CAP



| Code | Diameter |
|-------------------|----------|
| 7122100040 | 100 |
| 7122160040 | 150 |
| 7122200040 | 200 |

PIPE TRANSITION ADAPTER



| Code | Diameter |
|-------------------|----------|
| 7122100090 | 100 |
| 7122160090 | 150 |
| 7122200090 | 200 |

Our Quality

Input Quality Control

All kinds of raw materials and auxiliary materials supplied from our suppliers are subjected to Input Quality Control tests according to the quality-production standards determined by FIRAT. Samples taken from each lot of raw materials and auxiliary materials delivered in lots by our suppliers in compliance with "acceptance sampling" standard are required to pass Physical Suitability, Chemical Suitability, Density, MFI, Humidity, Bulk Density, Viscosity Number, Grain Thickness Distribution, K Number and Homogeneity tests at Input Quality Control Laboratories and raw material is required to obtain "**Suitable for Production**" approval.

Process Quality Control

During production process which is carried out by using raw materials and auxiliary materials that have "Suitable for Production" approval, samples taken from production lines during production stage and right after production are subjected to Process Quality Control tests which are determined by (TSE) and international (DVGW, SKZ, EN, DIN, etc.) standards institutions at the laboratories of FIRAT. Main Process Quality Control tests are as follows.

- * Impact Resistance Test
- * Hydrostatic Pressure Test
- * Lengthwise Change Test
- * Density Test
- * Homogeneity Test
- * Melting Flow Rate Test
- * Plasticizing Control Test
- * Vicat Test

Quality Tests *



Density Test



Melting Flow Rate Test



Homogeneity Test

During Process Quality Control stage, diameter, wall thickness and ovality measurements are performed simultaneously with the production with full automation using ultrasonic measurement devices installed on production lines, faulty production is avoided with the sound and light warning system which is activated in out-of-standard conditions. Our products are required to get **“Quality Approval”** upon passing all tests carried out in control frequencies and quantities specified in the standards.

Output-Final Quality Control

Our products with quality approval are subjected to Packaging and Package Suitability, Identification and Label Suitability checks and required obtain **“Suitable for Shipping”** approval upon packaging and packing phases.

All of our products are subject to quality and hygiene suitability tests with samples taken from our production lines semi-annually and regularly by the representatives of national (T.S.E.) and international GOST (Russia - Ukraine), SKZ (Germany), VDE (Germany), RAL (Germany) test and certification institutions in addition to the quality control tests performed at the laboratories of FIRAT.

Our products which pass these tests and satisfy the required quality conditions are offered to our customers.

*FIRAT owns the most advanced quality, control and test laboratories of its sector.



Impact Resistance Test



Pressure Test



Vicat Test

Quality and Control Assurance

Pipes and fittings are subjected to a series of quality tests performed through the process including inputs and laboratory, production and output final inspections performed after the process and out of tolerance productions are prevented through the processes which are subject to continuous parameter monitoring.

FIRAT has all kinds of technological facilities, laboratories, equipment, infrastructure and knowledge to ensure raw material, production, packaging and shipping quality controls and their continuity for Tunnel Type uPVC Drainage Piping and Fittings which provide the required quality standards.

Pursuant to ISO 9001 quality management system, PVC raw material is subjected to standard tests regularly on lot basis at FIRAT. Tests such as K Value, Grain Thickness, Viscosity, Burning Curve, Moisture Analysis, Component Determination are performed on raw materials which constitutes the formulation of uPVC Tunnel Type Drainage Pipes and Fittings and only raw materials which have Input Quality Control Approval are introduced to production. Raw materials which are formulated prior to production are introduced to production with full automatic system without manual intervention.

PVC Rawmaterial Technical Data

| Features | Unit | Value |
|-----------------------|------|--------|
| Color | | Blue |
| Form | | Powder |
| Vicat Softening Point | °C | > 77 |
| Elasticity Module | Mpa | > 2500 |

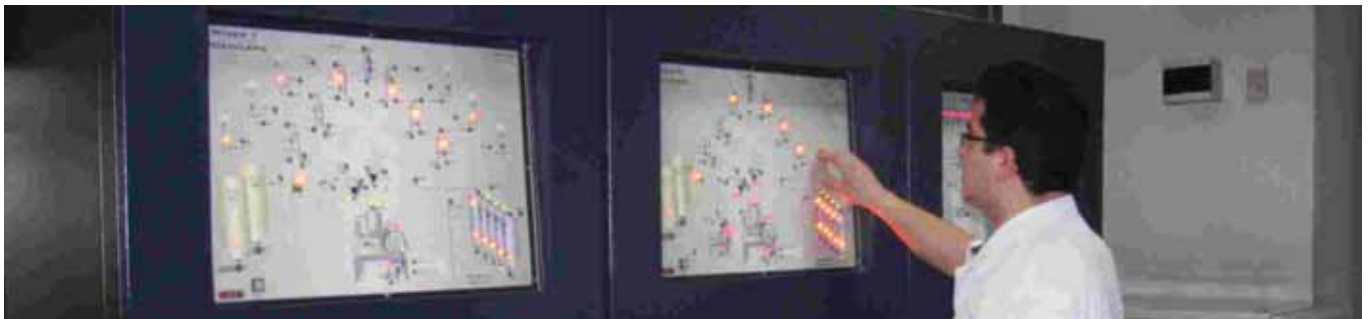

Our Quality Certificates



Features of Tunnel Type uPVC Drainage Pipe and Fittings

Tunnel Type uPVC Pipes and Fittings Chemical Resistance

uPVC Pipes and Fittings Chemical Resistance Table*

| Name of the Substance | Concentration % | 20°C | 60°C |
|---------------------------|------------------|------|------|
| Adipic Acid | doy.çöz | D | SD |
| Allyl Alcohol | ts-s | SD | DZ |
| Aluminum Fluoride | susp. | D | DZ |
| Aluminum Oxychloride | susp. | D | D |
| Ammoniac, hydrous | doy.çöz | D | D |
| Ammonium Fluoride | up to 20 | D | SD |
| Ammonium Hydro Carbonate | doy.çöz | D | D |
| Ammonium Sulfur | doy.çöz | D | D |
| Acetan Hydride | ts-s | DZ | DZ |
| Copper (II) Chloride | doy.çöz | D | D |
| Copper (II) Nitrate | doy.çöz | D | D |
| Barium Hydroxide | doy.çöz | D | D |
| Barium Carbonate | doy.çöz | D | D |
| Barium Sulfate | doy.çöz | D | D |
| Benzaldehyde | ts-s | DZ | DZ |
| Benzene | ts-s | DZ | DZ |
| Gasoline (Fuel) | working solution | D | D |
| Benzoic Acid | doy.çöz | SD | DZ |
| Borax | solution | D | D |
| Bromium, liquid | ts-s | DZ | DZ |
| Butane, gas | ts-g | D | D |
| Mercury Chloride | doy.çöz | D | D |
| Zinc Chloride | doy.çöz | D | D |
| Zinc Sulfate | doy.çöz | D | D |
| Dichlor Acetic Acid | ts-s | DZ | DZ |
| Dichlor Ethylenes | ts-s | DZ | DZ |
| Apple Juice | çal.çöz. | D | D |
| Ethyl Ether | ts-s | DZ | DZ |
| Ethylene Glycol | ts-s | D | D |
| Fluorine, gas, moist | ts-g | DZ | DZ |
| Phosphine | ts-g | D | D |
| Phosphor Oxychloride | ts-s | DZ | DZ |
| Glycerin | ts-s | D | D |
| Air | ts-g | D | D |
| Hydroquinone | doy.çöz | D | D |
| Hydrochloric Acid | up to 10% | D | D |
| Tin (II) Chloride | doy.çöz | D | D |
| Calcium Hydrogen Sulfur | çöz. | D | D |
| Calcium Hydroxide | doy.çöz | D | D |
| Calcium Carbonate | susp. | D | D |
| Calcium Nitrate | doy.çöz | D | D |
| Calcium Sulfate | susp. | D | D |
| Carbon dioxide, humid gas | ts-g | D | D |

*ISO-TR 10358 norm applies to chemicals not included in the table.

uPVC Boru ve Ek Parçaların Kimyasal Maddelere Dayanım Tablosu*

| Name of the Substance | Concentration % | 20°C | 60°C |
|----------------------------|-----------------|------|------|
| Carbondioxide, aqu. sol. | doy.çöz | D | D |
| Carbon monoxide, gas | ts-g | D | D |
| Chloro Benzene | ts-s | DZ | DZ |
| Chloro Form | ts-s | DZ | DZ |
| Sulfur Dioxide | | D | D |
| Magnesium Hydroxide | doy.çöz | D | D |
| Magnesium Nitrate | doy.çöz | D | D |
| Magnesium Sulfate | doy.çöz | D | D |
| Malic Acid | çöz. | D | D |
| Methyl Acetate | ts-s | DZ | DZ |
| Methyl Ethyl Ketone | ts-s | DZ | DZ |
| Methylene Chloride | ts-s | DZ | DZ |
| Nickel Chloride | doy.çöz | D | D |
| Nickel Nitrate | doy.çöz | D | D |
| Nickel Sulfate | doy.çöz | D | D |
| Nitrobenzene | ts-s | DZ | DZ |
| Oxygen, gas | ts-g | D | D |
| Oleic Acid | ts-s | D | D |
| Oxalic Acid | doy.çöz | D | D |
| Potassium Bicarbonate | doy.çöz | D | D |
| Potassium Bisulfate | doy.çöz | D | D |
| Potassium Fluoride | doy.çöz | D | D |
| Potassium Hydrogen Sulfide | çöz. | D | D |
| Potassium Hydroxide | solution | D | D |
| Potassium Chlorate | doy.çöz | D | D |
| Potassium Chloride | doy.çöz | D | D |
| Potassium Persulfate | doy.çöz | D | SD |
| Potassium Sulfate | doy.çöz | D | D |
| Citric Acid | doy.çöz | D | D |
| Sodium Bicarbonate | doy.çöz | D | D |
| Sodium Ferricyanide | doy.çöz | D | D |
| Sodium Ferrocyanide | doy.çöz | D | D |
| Sodium Hydrogen Sulfide | doy.çöz | D | D |
| Sodium Carbonate | doy.çöz | D | D |
| Sodium Nitrate | doy.çöz | D | D |
| Sodium Silicate | çöz. | D | D |
| Sodium Sulfate | doy.çöz | D | D |
| Sulfuric Acid | up to 50% | D | D |
| Tannic Acid | çöz. | D | D |
| Tetrahydrofurane | ts-s | DZ | DZ |
| Toluene | ts-s | DZ | DZ |
| Trichloroethylene | ts-s | DZ | DZ |
| Vinyl Acetate | ts-s | DZ | DZ |

*ISO-TR 10358 norm applies to chemicals not included in the table.

Abbreviations and Definitions

D: Resistant

No adverse change occurs in the properties of plastic pipes and fittings which are indicated with “D” symbol in the table when used under specified temperatures and with chemicals with specific concentrations unless a mechanical factor acts on them.

SD: Limited Resistant

Certain amount of corrosion may occur with the plastic pipes and fittings which are indicated with “D” symbol in the table when used under specified temperatures and with chemicals with specific concentrations unless a mechanical factor acts on them. Therefore, pipes indicated with “SD” can be used in applications where minimal amount of corrosion is admissible.

DZ: Not Resistant

Plastic pipes and fittings which are indicated with “DZ” symbol in the table are not employed since they are highly affected by chemicals.

ts-s Technical purity, liquid

ts-g Technical purity, gas

doy. çöz. Saturated solution

çal.çöz Working solution, is the most widespread concentration used in industry

çöz. Solution

FIRAT sells to a lot of Countries in Europe, Asia and Africa

Countries to which FIRAT exports:

| | | |
|------------------------|-----------------------|----------------------|
| Afghanistan | Hungary | Palestine |
| Albania | Iceland | Pakistan |
| Algeria | India | Poland |
| Armenia | Iran | Portugal |
| Azerbaijan | Iraq | Qatar |
| Bangladesh | Italy | Romania |
| Bahrain | Jordan | Russia |
| Belarus | Kazakhstan | Saudi Arabia |
| Belgium | Kenya | Serbia |
| Bulgaria | Kosovo | Slovakia |
| Bosnia and Herzegovina | Kuwait | Slovenia |
| Brasil | Kyrgyzstan | South Africa |
| China | Lebanon | Spain |
| Croatia | Latvia | Sudan |
| Czech Republic | Libya | Sweden |
| Denmark | Luxemburg | Syria |
| Dubai | Macedonia | Tajikistan |
| Egypt | Maldives | Tanzania |
| England | Malta | Tunisia |
| Ethiopia | Moldova | Turkmenistan |
| France | Montenegro | Ukraine |
| Gabon | Mongolia | United Arab Emirates |
| Gambia | Morocco | Union of the Comoros |
| Georgia | Netherlands | Uzbekistan |
| Germany | New Zealand | Yemen |
| Ghana | Nigeria | |
| Greece | TR of Northern Cyprus | |